

EXTECH[®]

USER MANUAL

Video Particle Counter with built-in Camera Model VPC300

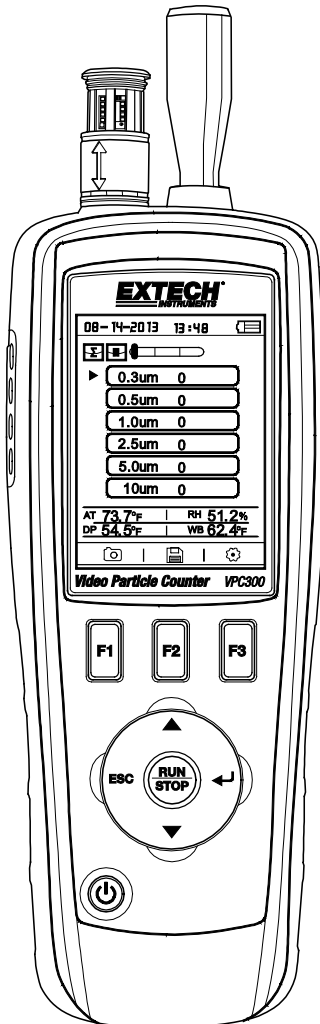

Additional User Manual Translations available at www.extech.com

Introduction

Thank you for selecting the Extech Instruments Model VPC300 Particle Counter with Camera.

The VPC300 has a Color TFT LCD display, a 74MB internal data storage bank, a micro-SD memory card slot for capturing images and video for viewing on a PC, and a built-in 320x240 pixel camera for capturing stills/video of test locations. The VPC300 offers quick and accurate readings for particle count, air temperature, most surface temperatures, and relative humidity. The VPC300 also offers a Dew Point and Wet Bulb temperature calculation geared for energy efficiency and environmental protection applications. Supplied PC software allows the user to generate reports based on records data, images, and video.

This device is shipped fully tested and calibrated and, with proper use, will provide years of reliable service. Please visit our website (www.extech.com) to check for the latest version of this User Guide, Product Updates, and Customer Support.

Features

- 2.8" TFT Color LCD display
- Convenient keystroke menu structure for measurements, setup, and other programming
- 320 x 240 pixel built-in camera for still and video imaging
- JPEG images and 3GP video
- Meter's internal memory 74MB.
- Meter can store 5000 records (date, time, counts, humidity, temperature, sample volumes) and 20 minutes of video to internal memory.
- Micro-SD memory card slot (8GB maximum); card not included.
- Selectable Test sample time, count data, and programmable delay
- Simultaneously measure and display 6 channels of particle sizes (down to 0.3µm)
- Air temperature and relative humidity
- Dew point and Wet bulb temperature calculations
- MIN/MAX/AVG/DIF record with date/time stamp
- Auto power off
- Language selection for English, French, German, and Spanish
- Meter is shipped NIST calibrated with calibration certificate
- Tripod mounting option
- Includes universal AC adaptor/charger with a variety of plug options, USB cable, PC software, tripod, Zero count filter, 7.4V Lithium-ion polymer rechargeable battery, and protective case

Meter Description

1. Isokinetic probe
2. Temperature and RH Sensor (note its protective cover that slides up and down)
3. Color TFT LCD
4. Compartment for USB interface port and AC Adaptor/Charger
5. Function F1, F2, F3 buttons
6. Control buttons: Page Up/Down, Enter, Run/Stop, and ESC
7. ON/OFF button
8. Battery and Micro-SD card compartment (SD card slot underneath battery)
9. Tripod mount
10. Camera lens

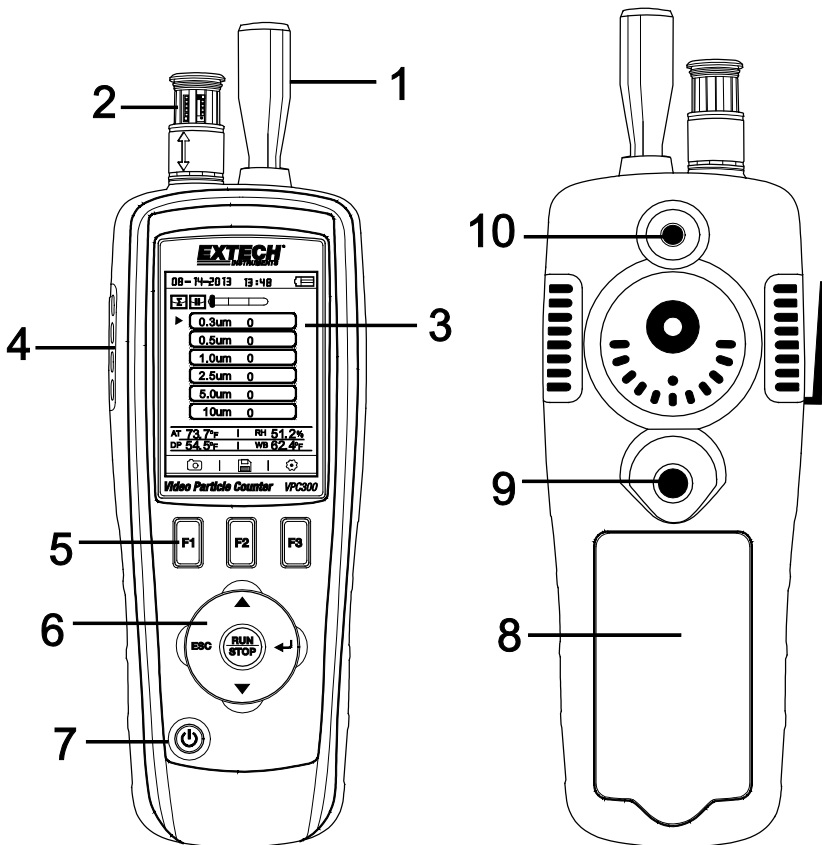

Operation

Power ON-OFF

Press and hold the power button to switch the instrument ON or OFF.

Important Notes

Note: Operating the particle counter with the isokinetic probe cap in place will damage the pump and other internal components.

Note: Electrical noise, sensor leakage, or other interference may cause the VPC300 to show incorrect particle count data.

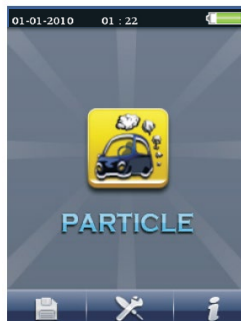

Getting Started

When the meter powers ON, the Particle Counter icon is displayed at the center of the LCD and the date, time, and battery status can be observed on the top row of the LCD. Three bottom row options are also displayed and can be selected using the Function keys (F1, F2, and F3) as shown below. These are explained in greater detail later in this user guide:



Memory (where data, images, and video are located)



System Setup Parameters



Help File

Symbol Glossary

	Cumulative mode		Video Record start
	Concentration mode		Video mode
	Test is paused		Color coded particle scale (green is low, yellow is moderate, and red is high particle count)
	CAM (Camera) mode		Alarm ON
	Differential mode		Battery Status
	Test is running		Particle Count Setup

Sequence of Operation

To ensure that you measure the amount of particles accurately, perform this sequence of operation.

1. Zero the particle count sensor
2. Setup your counter for proper operation. Sample time, mode, cycle, and interval.
3. Run your test cycles and evaluate the results.

Basic Operation

Press and hold the ON/OFF button for 3 to 5 seconds until the display illuminates to power on the meter.

Press the ENTER button (↵) to get to setup mode.

Press F3 to enter settings mode.

Set each parameter to your preferred setting by pressing ENTER to enter each parameter. Then press ENTER to enable editing of each parameter. Press ESC to exit parameter setup.

Sample Time: Length of time each test runs (3 to 60 seconds)

Start Delay: Duration of time from RUN to actual start of test. (3 to 100 seconds)

Channel Display: Particle sizes displayed during test.

Ambient Temp/RH: Allows the display of the air temp and %RH values

Sample Cycle: Number of test cycles to run (1 to 100)

Sample Mode: Cumulative, differential, concentration

Interval: Test cycle delay measured in seconds.



Level Indication: Particle level selection (highlighted on display)

Press ESC to return to testing screen

Press RUN/STOP to start the automated test sequence.

Taking Measurements

After powering the meter, press the Enter (↵) button to access the Particle Measurement screen. Then open the temperature/RH sensor by sliding its protective cover downward.

When measuring particle counts, these icons    correspond to the function keys (F1,F2,F3). F1 is to enter Camera and video mode, F2 is to view your saved data, and F3 is for Setup mode.

The display will show the particle count channels with readings, air temperature (AT), Dew point temperature (DP), Wet bulb temperature (WB), and Relative Humidity (%RH) as shown in accompanying diagram.

Press the RUN/STOP button to start the air pump and the particle count measurement process. When the programmed sampling time has elapsed, the particle measurement cycle will automatically end and the measurement data will be automatically stored. To set the sampling time, refer to the Particle Count SETUP MODE section. If desired, press the RUN/STOP button and stop the session manually.





Capturing Images

While measuring particle counts, press F1 to enter the camera mode. Press F1 to capture a Still image. Then press F1 to Save the image or F3 to delete it. Press ESC to get back to exit this mode.

Capturing Video

While measuring particle counts, press F1 to enter the camera mode. Press F3 to enter the video mode. The LCD will show . Now press F2 to capture video and press F2 again to stop the video capture. The video file will be automatically stored. The System Setup mode section allows the user to store video to the meter's internal memory or to an installed Micro-SD card. Press ESC to exit this mode.

Particle Counter Setup Mode

When measuring, these display icons    are visible. Press F3 to enter the Setup mode. Use the up and down arrow keys to select an option to edit and press Enter (↵) to access the selection.

SAMPLE TIME (Test Cycle Time)

Select Sample Time. Press the Enter (↵) button to enter the option and Press Enter (↵) again to activate the setting for editing. Use the arrow buttons to set the sampling time/gas volume (3 to 60 seconds). Use the Esc button to save and return to the menu.

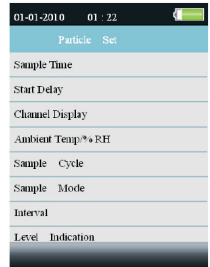

START DELAY

The test start delay time is adjustable (3 to 100 seconds). From the Particle setup menu, use the Up and Down arrows to select Start Delay. Press the Enter (↵) button to enter the option and Press Enter again to activate the setting for editing. Use the arrow keys to select the desired delay time. The test will not start until the programmed delay time has elapsed. Use the Esc button to save the setting and to return to the menu.

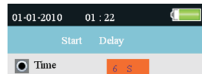
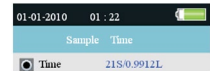

CHANNEL DISPLAY

Select channels that are to be displayed. From the Particle setup menu, use the Up and Down arrows to select Channel Display. Press the Enter (↵) button to enter the option. Use the arrow keys to select the channel and press the Enter key to select or de-select the channel. Use the Esc key to save the setting and to return to the menu.

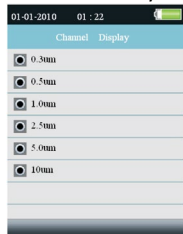

AMBIENT TEMPERAURE / %RH

Enable or Disable the ambient temperature and relative humidity displays. From the Particle setup menu, use the Up and Down arrows to select Ambient Temp/RH. Press the Enter (↵) button to enter the option. Use the arrow keys to select Enable or Disable and use the ESC button to save and return to the menu.



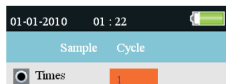

SAMPLE CYCLE

Set the desired number of test cycles to run. From the Particle setup menu, use the Up and Down arrows to select Sample Cycle. Press the Enter (↵) button to enter the option and Press Enter again to activate the setting for editing. Use the arrow keys to select the number of cycles to run the test (1 to 100). Press ESC to save setting and to return to the menu.



SAMPLE MODE

Select desired mode ( Cumulative,  Differential, or  Concentration). From the Particle setup menu, use the Up and Down arrows to select Sample Mode. Press the Enter (↵) button to enter the option. Use the arrow buttons to select desired mode and then use ESC to save and to return to the menu.

Cumulative Mode – measures all particles that are greater than or equal to the particle size selected in the Sample Volume field.

Differential Mode – measures all particles that are greater than or equal to the particle size selected in the Sample Volume field, but less than the next largest particle size.

Concentration Mode – used to take a quick sample of airborne particulates, performed especially in areas where the particulate levels are unknown and may exceed the operating levels of this counter.

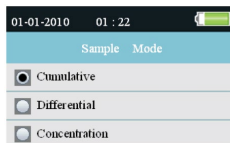

INTERVAL (TIME BETWEEN REPEATED TEST CYCLES)

Set the time between tests for tests with more than one cycle (1 to 100 seconds). From the Particle setup menu, use the Up and Down arrows to select Interval Time. Press the Enter (↵) button to enter the option and Press Enter again to activate the setting for editing. Use the arrow buttons to set the desired interval time. Use the ESC button to save setting and to return to the menu. **Note:** The INTERVAL setting is only for programming the time between test cycles, not between individual measurements.



LEVEL (ALARM LIMIT) INDICATION

Select the Alarm Limit (Level) of the corresponding particle size. When the selected particle size is exceeded, the instrument alerts the user. From the Particle setup menu, use the Up and Down arrows to select Level Indication. Press the Enter (↵) button to enter the option. Use the arrow buttons to select the desired alarm limit and then press ESC to save setting and return to the menu



Memory Storage Browser

When the meter is switched ON, these LCD icons are visible .

Press F1 to enter the data memory section. There are three options available in the memory mode, Picture, Video, and Particle Logs.

Use the arrow buttons to select one and then press ENTER (↵) to access the selection.

When browsing images, data, and video use the arrow buttons to navigate, use the Enter button to select, and use the ESC or F3 button to return to the menu.

Press ESC again to exit to the power-on screen.



System Setup Parameters

When the meter is switched ON, these LCD icons are visible . Click on the F2 key and the menu will appear. Detailed explanations are provided below for each parameter. Use the Arrow keys to choose the desired parameter.

DATE/TIME

Set the Date and Time. Press the Enter (↵) button to open the selection for editing. Use the arrow keys to change a value, and use the Enter button to go to the next item. Press the ESC button to save the setting return to the Setup menu.

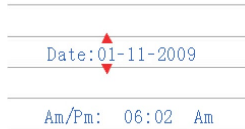

FONT COLOR

Select the color for the Display font. Press the Enter (↵) button to open the selection for editing. Use the arrow keys to select a color and use the ESC button to save the setting and return to the Setup menu.



LANGUAGE

Select the desired language for menu text. Press the Enter (↵) button to open the selection for editing. Use the arrow keys to select a language and use the ESC button to save the setting and return to the Setup menu.

BRIGHTNESS

Adjust the display to the desired brightness level. Press the Enter (↵) button to open the selection for editing. Use the arrow keys to select a level and use the ESC button to save the setting and return to the Setup menu.

- 100%
- 90%
- 80%
- 70%
- 60%
- 50%
- 40%
- 30%

AUTO POWER OFF

Select elapsed time value before meter switches OFF. Press the Enter (↵) button to open the selection for editing. Use the arrow keys to select the setting and use the ESC button to save the setting and return to the Setup menu.

- Disabled
- 3 Min
- 15 Min
- 60 Min

DISPLAY TIME-OUT

Select display auto-off delay. Press the Enter (↵) button to open the selection for editing. Use the arrow keys to select a setting and use the ESC button to save the setting and return to the Setup menu.

- Disable
- 90s
- 2 Min
- 4 Min

MEMORY STATUS

Display the memory and the micro-SD card status. Press the Enter (↵) button to open the selection for editing. Use the arrow keys to select 'Device' or 'SD Card' and then view the status for the selected item. Use the ESC button to return to the Setup menu.

<input checked="" type="radio"/> Device
<input type="radio"/> SD Card
Total: [74] MB
Used: [0] MB
Free: [74] MB (100%)

FACTORY DEFAULT

Restore factory default settings. Press the Enter (↵) button to open the selection for editing. Use the arrow keys to select YES or NO and then use the ESC button to save the setting and return to the Setup menu.

<input type="radio"/> No
<input checked="" type="radio"/> Yes

UNITS

Select the desired unit of measure for temperature C or F. Press the Enter (↵) button to open the selection for editing. Use the arrow keys to select the Unit and use the ESC button to save the setting and return to the Setup menu.

<input type="radio"/> ° C
<input checked="" type="radio"/> ° F

Zero the Particle count Sensor

Particles must be purged (removed) from the sensor before and after each use in a high sample count environment.

Zero the sensor:

1. Unscrew and remove the Isokinetic probe and attach the Zero count filter.
2. Turn on the meter and in the Setup mode,
 - a. Set the Sample mode to Cumulative.
 - b. Set the Channel Display to ensure all channels are selected.
 - c. Set Sample time to 60 seconds
 - d. Set Sample Cycle to 10
3. Start the meter
4. Allow the meter to run until all of the particle counts read zero. You may need to run the meter multiple times to ensure that all channels read zero.
5. Turn off the meter.
6. Remove the Zero count filter and attach the Isokinetic probe.

Particle Count Table

Particle count readings, grouped by color, Green (good), Yellow (caution), and Red (hazard), are shown for each channel.

Channel	Green	Yellow	Red
0.3um	0 to 100,000	100,001 to 250,000	250,001 to 500,000
0.5um	0 to 35,200	35,201 to 87,500	87,501 to 175,000
1.0um	0 to 8,320	8,321 to 20,800	20,801 to 41,600
2.5um	0 to 545	546 to 1,362	1,363 to 2,724
5.0um	0 to 193	194 to 483	484 to 966
10.0um	0 to 68	69 to 170	171 to 340

Note: This table is intended for reference use only

Particle Counter Considerations

Particle pollution is a mixture of various components including smoke, dust, chemicals, mold, and gases. Particle concentrations can affect our health and comfort levels. Evaluating the quality of the air by determining the concentration and size of these particles can help to determine if a problem exists. Locating the source of these various particles can help to determine effective methods of reducing these and improving the Indoor Air Quality (IAQ).

One way to determine the source of air particulates in a room is to test the air outside of the room under investigation. Determine the concentration and size of particulates at the air intake to that room. Purge or Zero the particle counter and then measure the concentration and size of particles in multiple areas of the room to be tested, to determine the effectiveness of the incoming air filtration. The air temperature, relative humidity, and CO2 levels are also an important consideration for IAQ as high humidity and lower temperatures can bring about mold creation.

If a room is classified as an ISO clean room or clean zone, the counts of particle sizes for that class cannot be exceeded when tested.

Refer to the ISO Clean Room Class chart (ISO 14644-1:1999) for values.

The VPC300 is equipped with a still/video camera to directly see the areas under test. Data, images, and video can be stored on up to an 8GB micro-SD card (not included) or in the meter's internal 74MB memory.

The life of the meter can be maximized by testing only when necessary and securely storing the instrument when it is not in use. Continuous use is not recommended and can shorten the life of the instrument especially in dusty environments. Setting up a common sense maintenance schedule and testing to the schedule will go a long way in lengthening the life of the instrument sensor.

PC Interface and Supplied PC software

PC Software

This meter has the capability to connect to and communicate with a PC. Check the software download page of the website www.extech.com/software for the latest version of the PC software and its operating system compatibility.

Download and unzip the software. Run ExtechInstaller.exe and then refer to the instructions provided in the HELP Utility within the software program.

Battery Charging and Replacement

When the battery icon appears drained on the LCD or if the meter will not switch ON, the battery must be recharged using the supplied AC adaptor/charger. The charger plug connects to the jack located on the meter's left side compartment.

The battery compartment is located on the rear of the instrument.

The battery is a 7.4V-Lithium-ion polymer rechargeable battery.

To access the meter's battery for replacement:

1. On the rear of the meter, remove the Phillips head screw that secures the battery compartment.
2. Open the compartment by carefully lifting the compartment cover.
3. Replace the battery with one of the same type (note that the Micro-SD card slot is located underneath the battery as explained below).
4. Close the compartment and secure the compartment cover with the Phillips head screw

Battery Safety Reminders

- Please dispose of batteries responsibly; observe local, state, and national regulations.
- Never dispose of batteries in fire; batteries may explode or leak.
- Always install a new battery of the same type.

Micro-SD Card Slot (optional)

The micro-SD card slot is located inside the battery compartment underneath the battery. Micro-SD cards up to 8GB can be inserted in the slot.

To access the SD memory card slot:

1. Turn off power to the meter and remove the AC adapter cable if connected.
2. Open the battery compartment as described in the battery replacement section.
3. Remove the battery.
4. Insert a micro-SD card (8GB max.) in the card slot underneath the battery by lifting up on the metal card holder and placing the Micro SD card in the connector. The pins facing towards the top of the meter. Close the metal holder.
5. Insert the battery and secure the compartment cover before powering on the meter.

Specifications

Particle Counter

Channels	Six channels: 0.3, 0.5, 1.0, 2.5, 5.0, 10 μ m
Flow Rate	0.1ft ³ /min (2.83L/min)
Counting Efficiency	50% at 0.3 μ m; 100% for particles > 0.45 μ m
Coincidence Limit (Coincidence Loss)	5% at 2,000,000 particles per ft ³
Particle Count Modes	Cumulative, Differential, and Concentration modes

Air Temperature and Relative Humidity Measurements

Air Temperature Range	32 to 122°F (0 to 50°C)
Dew Point/Wet Bulb Temperature Range	32 to 122°F (0 to 50°C)
Relative Humidity Range	0 to 100%RH
Air Temperature Accuracy	±0.9°F (0.5°C) 50 to 104°F (10°C to 40°C) ±1.8°F (1.0°C) all other ranges
Dew Point/Wet Bulb Temperature Accuracy	±0.9°F (0.5°C) 50 to 104°F (10°C to 40°C) 1.8°F (1.0°C) all other ranges ±3.5%RH from 20 to 40%RH and from 60 to
Relative Humidity Accuracy	±3%RH from 40 to 60%RH 80%RH ±5.0%RH from 0 to 20%RH and from 80 to 100%RH

General Specifications

Display	2.8" 320 x 240 pixel TFT Color LCD
Low battery indication	Battery symbol appears on the LCD
Micro-SD Card Slot	Accommodates up an 8GB card
Meter internal memory	5000 sample records; 74MB
Power supply	Rechargeable 7.4V Lithium-ion polymer battery
Battery life	Approx. 4 hours of continuous use
Battery charge time	2 hours approx. with AC adaptor/charger
Operating Temperature	32 to 122°F (0 to 50°C)
Operating/Storage Humidity	10 to 90% RH non-condensing
Storage Temperature	14 to 140°F (-10 to 60°C)
Dimensions	9.4 x 3.0 x 2.2" (240 x 75 x 57mm)
Weight	1.26 lbs. (570g)

Two-year Warranty

Teledyne FLIR warrants this Extech brand instrument to be free of defects in parts and workmanship for **two years from date of shipment (a six-month limited warranty applies to sensors and cables). To view the full warranty text please visit:**

<http://www.extech.com/support/warranties>.

Calibration and Repair Services

Teledyne FLIR offers calibration and repair services for the Extech brand products we sell. We offer NIST traceable calibration for most of our products. Contact us for information on calibration and repair availability, refer to the contact information below. Annual calibrations should be performed to verify meter performance and accuracy. Product specifications are subject to change without notice. Please visit our website for the most up-to-date product information:

www.extech.com.

Contact Customer Support

Customer Support Telephone List: <https://support.flir.com/contact>

Calibration, Repair, and Returns: repair@extech.com

Technical Support: <https://support.flir.com>

Copyright © 2022 Teledyne FLIR Commercial Systems, Inc.

All rights reserved including the right of reproduction in whole or in part in any form

www.extech.com

This document does not contain any export-controlled information