

## Heavy Duty Differential Pressure Manometer

Model SDL710

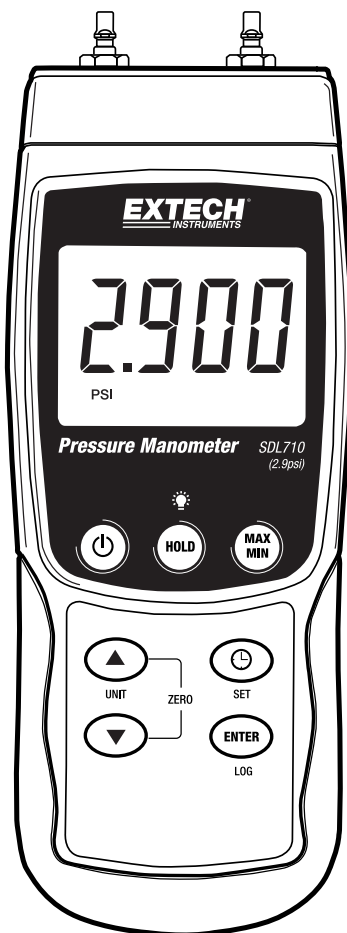

# Introduction

Congratulations on your purchase of the Extech SDL710 Pressure Manometer. This device measures gauge and differential pressure in the range of  $\pm 2.9$  psi. Supported measurement units are mbar, psi, Kg/cm<sup>2</sup>, mm Hg, inch Hg, meters of H<sub>2</sub>O, inches of H<sub>2</sub>O, atmosphere, hPA, and kPA. Logged data readings are stored on an SD card for transfer to a PC. This meter is shipped fully tested and calibrated and, with proper use, will provide years of reliable service. Please visit our website ([www.extech.com](http://www.extech.com)) to check for the latest version of this User Manual, other Translations of this manual and Customer Support.









# Safety

## International Safety Symbols



This symbol, adjacent to another symbol or terminal, indicates the user must refer to the manual for further information.

# Meter Description

1. P1 Input (positive +)
2. P2 Input (negative -)
3. LCD Display
4. HOLD and Backlight  key
5. MAX-MIN key
6. SET and Clock  key
7. RS232 output jack
8. Reset button
9. Power Adaptor jack
10. SD card slot
11. ENTER and LOG key
12. Down arrow  key  
(Press  &  key at same time to zero meter)
13. Up arrow  / UNIT key  
(Press  &  key at same time to zero meter)
14. Power ON-OFF  key

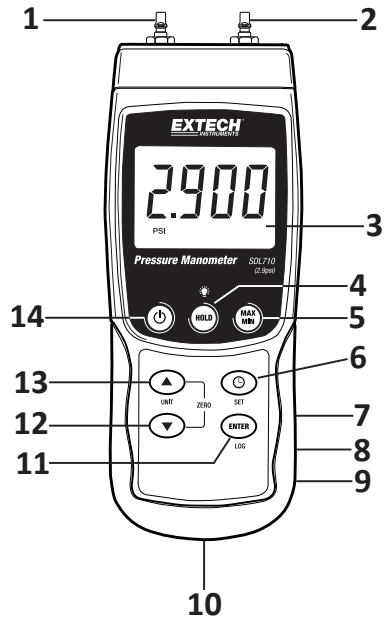

**Notes:** Items 7, 8, and 9 are located behind the snap-off compartment cover on meter's right side. Battery compartment, tilt stand, and tripod mount are located on the rear of the instrument.

# Getting Started

---

## Power ON-OFF

- Power the meter by pressing and holding the power button  for at least 1.5 seconds.
- Press and hold the power button for at least 1.5 seconds to power OFF the meter.
- This meter is powered by six (6) 1.5VDC 'AA' batteries or by optional AC adaptor. If the meter will not switch ON please check that fresh batteries are installed in the rear battery compartment or, in the case of the AC adaptor, check that the adaptor is connected correctly to the meter and to an AC source.

## Display Backlight



To turn the display backlight ON or OFF, press and hold the backlight  button for at least 1.5 seconds. The meter will beep when switching the backlight ON or OFF unless the beeper is disabled.

## Units of Measure

The currently selected unit of measure is shown below the measurement value on the meter's LCD. To change the unit of measure, press and hold the UNIT button until the desired unit of measure appears and then release the UNIT button. The meter begins scrolling through the available units of measure (see table below) after the UNIT button has been depressed for at least 1.5 seconds.

UNIT	DISPLAY INDICATOR
psi	PSI
Inch Hg	In Hg
Inch H <sub>2</sub> O	In H <sub>2</sub> O
hPA	hPA
kPA	_PA
Bar	bAr
Kg/cm <sup>2</sup>	_g C <sub>2</sub>
mm Hg	--Hg
Meters H <sub>2</sub> O	-t H <sub>2</sub> O
Atmospheres	AtP

## ZERO Adjustment

To null, or zero, the display for a connected sensor, press and hold the up  and down  arrow keys for at least 1.5 seconds. The meter will show CAL 0 on the bottom left of the screen.

## Data Hold

To freeze a displayed reading on the LCD, momentarily press the HOLD button (the HOLD icon will appear above the reading). To exit HOLD, press the HOLD button again.

# Setup Mode

---

## Basic settings at a glance

To view the current configuration of the meter with regard to time, date, and datalogging sampling rate press the SET button momentarily. The meter will now display the configuration in quick succession. If the information is missed on the first try, simply press the SET button again until all of the information is noted.

## Accessing the Setup mode

1. Press and hold the SET button for at least 1.5 seconds to access the Setup menu.
2. Press the SET button momentarily to step through the available parameters. The parameter type is shown on the bottom of the LCD and the current selection for that type is shown above it.
3. When a parameter is displayed that is to be changed, use the arrow keys to change the setting. Press the ENTER button to confirm a change.
4. Press and hold the SET button for at least 1.5 seconds to exit the Setup mode. Note that the meter automatically switches out of the Setup mode if no key is pressed within 7 seconds.
5. The available Setup parameters are listed below. Additional detailed information is provided below this list:

**dAtE** Set the clock (Year/Month/Date; Hours/Minutes/Seconds)

**SP-t** Set the datalogger sampling rate (Hours/Minutes/Seconds)

**PoFF** Automatic power-off management (Enable or disable the auto-power off function)

**bBEEP** Set the beeper sound ON/OFF

**dEC** Set the numerical format; USA (decimal: 20.00) or European (comma: 20,00)

**SdF** Format the SD memory card

## Setting the Clock Time

1. Access the **dAtE** parameter.
2. Use the arrow keys to change a value
3. Use the ENTER button to step through the selections
4. Press and hold the SET button for at least 1.5 seconds to exit to the normal operation mode (or simply wait 7 seconds for the meter to automatically switch to the normal operating mode).
5. The clock will keep accurate time even when the meter is switched off. However, if the battery expires the clock will have to be reset after fresh batteries are installed.

## Setting the Datalogger Sampling Time (Rate)

1. Access the **SP-t** parameter.
2. The sampling rate can be set from '0' seconds (manual log mode) up to 8 hours, 59 minutes, and 59 seconds. (Data lose may occur when logging at a 1 second rate)
3. Use the ENTER button to move through the Hours, Minutes, and Seconds digit groups and use the arrow keys to change the digit values.
4. Press the ENTER button to confirm the entry.
5. Press and hold the SET button for at least 1.5 seconds to exit to the normal operation mode (or simply wait 7 seconds for the meter to automatically switch to the normal operating mode).

## Enabling/Disabling the Auto Power OFF Feature

1. Access the **PoFF** parameter.
2. Use the arrow buttons to select ON or OFF. With the Auto Power OFF feature enabled, the meter will automatically switch OFF after 10 minutes of inactivity.
3. Press ENTER to confirm setting.
4. Press and hold the SET button for at least 1.5 seconds to exit to the normal operation mode (or simply wait 7 seconds for the meter to automatically switch to the normal operating mode).

## Set the Beeper Sound ON or OFF

1. Access the **bEEP** parameter.
2. Use the arrow buttons to select ON or OFF.
3. Press ENTER to confirm setting.
4. Press and hold the SET button for at least 1.5 seconds to exit to the normal operation mode (or simply wait 7 seconds for the meter to automatically switch to the normal operating mode).

## Numerical Format (comma or decimal)

European and USA numerical formats differ. The meter defaults to USA mode where a decimal point is used to separate units from tenths, i.e. **20.00**; The European format uses a comma, i.e. **20,00** to separate units from tenths. To change this setting:

1. Access the **dEC** parameter.
2. Use the arrow buttons to select USA or EUro.
3. Press ENTER to confirm setting.
4. Press and hold the SET button for at least 1.5 seconds to exit to the normal operation mode (or simply wait 7 seconds for the meter to automatically switch to the normal operating mode).

## SD Card FORMATTING

1. Access the **Sd F** parameter.
2. Use the arrow buttons to select YES to format the card (select NO to abort). Note that all data on the card will be lost if formatting is attempted.
3. Press ENTER to confirm selection.
4. Press ENTER again to re-confirm.
5. The meter will automatically return to the normal operating mode when formatting is complete. If not, press and hold the SET button for at least 1.5 seconds to exit to the normal operation mode.

## System Reset

If the meter's keys become inoperable or if the display freezes the Reset button can be used to reset the instrument.

- Use a paper clip or similar item to momentarily press the reset button located on the lower right side of the instrument under the snap-off compartment cover.
- After pressing the Reset button, switch the instrument ON by pressing and holding the POWER key for at least 1.5 seconds. If using the power adaptor unplug the adaptor and then plug it back in again to power the meter.

## Max-Min Reading Record

For a given measurement session, this meter can record the highest (MAX) and the lowest (MIN) readings for later recall.

1. Press the MAX-MIN button momentarily to access this mode of operation (REC icon appears)
2. The meter is now recording the MAX and MIN readings.
3. Press the MAX-MIN button again to view the current MAX readings (MAX icon appears). The readings on the display are now the highest readings encountered since the REC icon was switched on (when the MAX-MIN button was first pressed).
4. Press the MAX-MIN button again to view the current MIN readings (MIN icon appears). The readings on the display are now the lowest readings encountered since the REC icon was switched on (when the MAX-MIN button was first pressed).
5. To exit the MAX-MIN mode, press and hold the MAX-MIN button for at least 1.5 seconds. The meter will beep, the REC-MAX-MIN icons will switch off, the MAX-MIN memory will clear, and the meter will return to the normal operating mode.

## Fittings Connection

Connect tubing to the P1 (+), P2 (-), or both input port(s). If both inputs are used (differential mode), the meter displays a positive pressure reading if the P1 (+) pressure is greater than P2 (-) and a negative reading if P2 (-) is greater than P1 (+).

## Datalogging

---

### Types of Data Recording

- **Manual Datalogging:** Manually log up to 99 readings onto an SD card via push-button press.
- **Automatic Datalogging:** Automatically log data onto an SD memory card where the number of data points is virtually limited only by the card size. Readings are logged at a rate specified by the user.

### SD Card Information

- Insert an SD card (from 1G size up to 16G) into the SD card slot at the bottom of the meter. The card must be inserted with the front of the card (label side) facing toward the rear of the meter.
- If the SD card is being used for the first time it is recommended that the card be formatted and the logger's clock set to allow for accurate date/time stamping during datalogging sessions. Refer to the Setup Mode section for SD card formatting and time/date setting instructions.
- European and USA numerical formats differ. The data on the SD card can be formatted for either format. The meter defaults to USA mode where a decimal point is used to separate units from tenths, i.e. **20.00**. The European format uses a comma, i.e. **20,00**. To change this setting, refer to the Setup Mode section.

## Manual Datalogging

In the manual mode the user presses the LOG button to manually log a reading onto the SD card.

1. Set the sampling rate to '0' seconds as described in the Setup Mode section.
2. Press and hold the LOG button for at least 1.5 seconds and the DATALOGGER icon will appear on the LCD; the lower portion of the display will show p-n ( $n$  = memory position number 1-99). Note that if PSI is set as the unit of measure it appears as P51 (where a '5' is used as an 'S') in the same area of the LCD where memory locations are shown. This can be disorienting at first.
3. Momentarily press the LOG button to store a reading. The DATALOGGER icon will flash and the beeper will sound (if set to ON) each time a data point is stored.
4. Use the ▲ and ▼ buttons to select one of the 99 data memory positions in which to record.
5. To exit the manual datalogging mode, press and hold the LOG button for at least 1.5 seconds. The DATALOGGER icon will switch off.

## Automatic Datalogging

In automatic datalogging mode the meter takes and stores a reading at a user-specified sampling rate onto an SD memory card. The meter defaults to a sampling rate of two seconds. To change the sampling rate, refer to the Setup Mode section (the sampling rate cannot be '0' for automatic datalogging):

1. Select the sampling rate in the Setup Mode to a value other than zero.
2. Press and hold the LOG button for at least 1.5 seconds. The meter will flash the DATALOGGER icon at the selected sampling rate indicating that readings are now being automatically recorded to the SD card.
3. If a card is not inserted or if the card is defective, the meter will display EMPTY and exit the DATALOGGER mode. In this case, switch the meter OFF and try again with a valid SD card.
4. Pause the datalogger by pressing the LOG button momentarily. The DATALOGGER icon will stop flashing and the sample rate will display for a short time. To resume logging simply press the LOG button again momentarily.
5. To terminate the datalogging session press and hold the LOG button for at least 1.5 seconds.
6. When an SD card is used for the first time a folder is created on the card and named **PMA01**. Up to 99 spreadsheet documents (each with 30,000 readings) can be stored in this folder.
7. When datalogging begins a new spreadsheet document named **PMA01001.xls** is created on the SD card in the PMA01 folder. The data recorded will be placed in the PMA01001.xls document until 30,000 readings are reached.
8. If the measurement session exceeds 30,000 readings, a new document will be created (PMA01002.xls) where another 30,000 readings can be stored. This method continues for up to 99 documents, after which another folder is created (PMA02) where another 99 spreadsheet documents can be stored. This process continues in this same fashion with folders PMA03 through PMA10 (last allowable folder).

## SD Data Card to PC Data Transfer

1. Complete a datalogging session as detailed above in the previous sections. Hint: For the first few tests, simply record a small amount of test data. This is to ensure that the datalogging process is well understood before committing to critical, large scale datalogging.
2. With the meter switched OFF, remove the SD Card.
3. Plug the SD Card directly into a PC SD card reader. If the PC does not have an SD card slot, use an SD card adaptor (available where computer accessories are sold).
4. Power the PC and run a spreadsheet software program. Open the saved documents in the spreadsheet software program (see example spreadsheet data screen below).

### Spreadsheet data example

	A	B	C	D	E	F	G
1	Position	Date	Time	Ch1_Velo	Ch1_Unit		
2	1	2003/8/2	09:33:57	148.9	m Bar		
3	2	2003/8/2	09:33:58	146.1	m Bar		
4	3	2003/8/2	09:34:00	146.1	m Bar		
5	4	2003/8/2	09:34:02	145.1	m Bar		
6	5	2003/8/2	09:34:04	144.2	m Bar		
7	6	2003/8/2	09:34:06	143.2	m Bar		
8	7	2003/8/2	09:34:08	142.3	m Bar		
9	8	2003/8/2	09:34:10	141.4	m Bar		
10	9	2003/8/2	09:34:12	140.1	m Bar		
11	10	2003/8/2	09:34:14	138.7	m Bar		
12	11	2003/8/2	09:34:16	138.9	m Bar		
13	12	2003/8/2	09:34:18	139	m Bar		
14	13	2003/8/2	09:34:20	139	m Bar		
15	14	2003/8/2	09:34:22	139.1	m Bar		
16	15	2003/8/2	09:34:24	139.1	m Bar		
17	16	2003/8/2	09:34:26	139.1	m Bar		
18	17	2003/8/2	09:34:28	137.8	m Bar		
19	18	2003/8/2	09:34:30	111.6	m Bar		
20	19	2003/8/2	09:34:32	112.3	m Bar		
21	20	2003/8/2	09:34:34	112.3	m Bar		
22	21	2003/8/2	09:34:36	112.4	m Bar		
23	22	2003/8/2	09:34:38	112.4	m Bar		
24	23	2003/8/2	09:34:40	112.5	m Bar		
25	24	2003/8/2	09:34:42	101.8	m Bar		
26	25	2003/8/2	09:34:44	101.8	m Bar		
27	26	2003/8/2	09:34:46	101.8	m Bar		
28	27	2003/8/2	09:34:48	101.8	m Bar		

## AC Power Adaptor

This meter is normally powered by six (6) 1.5V 'AA' batteries. An optional 9V power adaptor is available. When the adaptor is used, the meter is permanently powered and the power button will be disabled.



## Hose Couplings

This meter is supplied with a pair of hose couplings. They fit 4.0 mm (0.157") tubing. See diagram on how to connect these couplings to the hose and the meter.

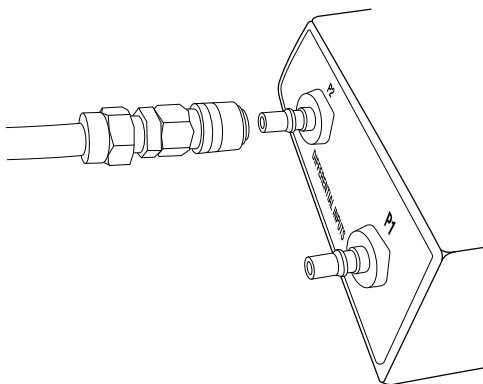
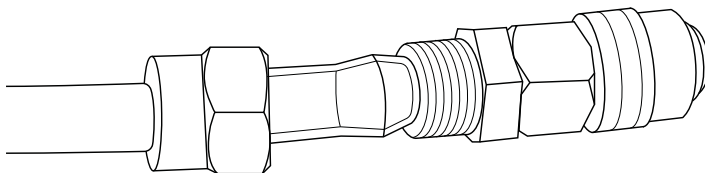

## Battery Replacement and Disposal

---

When the low battery icon  appears on the LCD, the batteries must be replaced. Several hours of accurate readings are still possible in this condition; however, batteries should be replaced as soon as possible:

- Remove the two (2) Phillips screws from the rear of the meter (directly above the top of the tilt stand).
- Remove and safely place the battery compartment and screws where they will not be damaged or lost.
- Replace the six (6) 1.5V 'AA' batteries observing correct polarity.
- Replace the battery compartment cover with the two (2) Phillips screws.



Never dispose of used batteries or rechargeable batteries in household waste.

As consumers, users are legally required to take used batteries to appropriate collection sites, the retail store where the batteries were purchased, or wherever batteries are sold.

**Disposal:** Do not dispose of this instrument in household waste. The user is obligated to take end-of-life devices to a designated collection point for the disposal of electrical and electronic equipment.

### Other Battery Safety Reminders

- Never dispose of batteries in a fire. Batteries may explode or leak.
- Never mix battery types. Always install new batteries of the same type.

# Specifications

---

## General Specifications

Display	Backlit LCD; LCD size: 51 x 37mm (2 x 1.5")
Status indicators	Over-range audible beep and low battery display icon 
Measurement Units	mBar, psi, Kg/cm <sup>2</sup> , hPA, mm Hg, inch Hg, meters H <sub>2</sub> O, kPA, inches H <sub>2</sub> O, and ATP
Accuracy (Meter)	± (2% F.S.) at ambient temperature 23°C (± 5°C)
Input circuit	Differential inputs (P1 and P2)
Input Ports	Two metal 5.0mm (0.197"), barbed for 4.0mm (0.157") ID tubing
Hose couplings	Replacement pair of hose couplings (407915)
Sensor	Built-in piezoelectric sensors
Datalogger Sampling Rate	AUTO LOGGING: From 1 second up to 8 hours 59 min 59 sec. (Data lose may occur when logging at a 1 second rate) MANUAL LOGGING: Set the sampling rate to '0' seconds. Select 1 to 99 locations.
Data error number	≤ 0.1% number of total saved data
Memory Card	SD memory card; 1G to 16GB size
Data Hold	Freeze the displayed reading
Memory Recall	Record and Recall the Maximum and Minimum readings
Display update rate	Approx. 1 second
Operating Temperature	0 to 50°C (32 to 122°F)
Operating Humidity	85% R.H. max.
Auto Power OFF	After 10 minutes of inactivity (can be disabled)
Power Supply	Six (6) 1.5 VDC batteries (optional 9V AC adaptor)
Power Consumption	Normal operation (backlight/datalogger OFF): approx. 7mADC With backlight OFF and datalogging ON: approx. 25mADC With backlight ON add approx. 10mADC
Weight	265g (0.59 lbs.)
Dimensions	190 x 68 x 45mm (7.5 x 2.7 x 1.8")

## Range/Resolution Specifications

Range/Units (Max.)	Resolution
± 200 mbar	0.1
± 2.9 psi	0.001
± 0.204 Kg/cm <sup>2</sup>	0.001
± 150 mm Hg	0.1
± 5.905 inches Hg	0.002
± 20 kPa	0.01
± 200 hPA	0.1
± 80.2 inches H <sub>2</sub> O	0.05
± 2.040 m H <sub>2</sub> O	0.001
± 0.197 ATP	0.001

## Conversions

---

Useful conversion Factors		
From	To	Multiplier
in of H <sub>2</sub> O	in of Hg	0.07355
in of H <sub>2</sub> O	cm of H <sub>2</sub> O	2.54
mm of Hg	in of H <sub>2</sub> O	0.53524

**Copyright © 2016 FLIR Systems, Inc.**

All rights reserved including the right of reproduction in whole or in part in any form

ISO-9001 Certified

**[www.extech.com](http://www.extech.com)**