

Extech EX830 True RMS 1000 Amp Clamp Meter with IR Thermometer

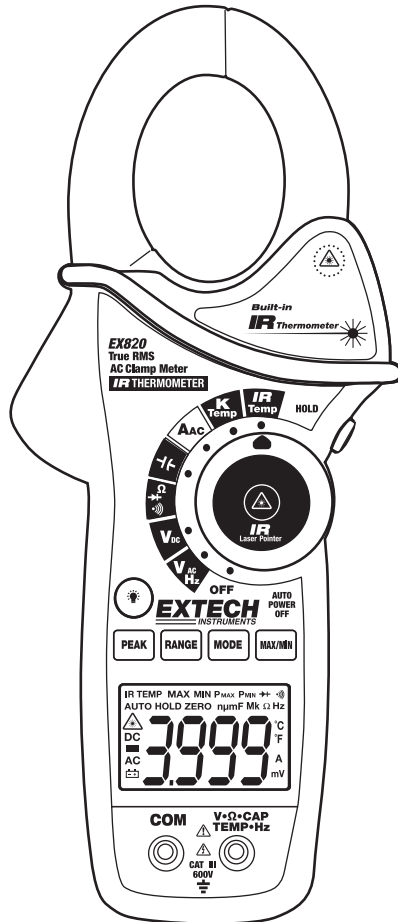

Introduction

Congratulations on your purchase of the Extech EX830 True RMS 1000A Clamp Meter. This meter measures AC/DC Voltage, AC/DC Current, Resistance, Capacitance, Frequency, Diode Test, Continuity, Type k thermocouple thermometer plus Non-Contact IR Temperature. Proper use and care of this meter will provide many years of reliable service.

Safety

International Safety Symbols



This symbol, adjacent to another symbol or terminal, indicates the user must refer to the manual for further information.



This symbol, adjacent to a terminal, indicates that, under normal use, hazardous voltages may be present



Double insulation

SAFETY NOTES

- Do not exceed the maximum allowable input range of any function.
- Do not apply voltage to meter when resistance function is selected.
- Set the function switch OFF when the meter is not in use.
- Remove the battery if meter is to be stored for longer than 60 days.

WARNINGS

- Set function switch to the appropriate position before measuring.
- When measuring volts do not switch to current/resistance modes.
- Do not measure current on a circuit whose voltage exceeds 600V.
- When changing ranges always disconnect the test leads from the circuit under test.

Function	Maximum Input
A AC, ADC	1000A DC/AC
V DC, V AC	600V DC/AC
Resistance, Capacitance, Frequency, Diode Test	250V DC/AC
Type K Temperature	60V DC, 24V AC

CAUTIONS

- Improper use of this meter can cause damage, shock, injury or death. Read and understand this user manual before operating the meter.
- Always remove the test leads before replacing the battery or fuses.
- Inspect the condition of the test leads and the meter itself for any damage before operating the meter. Repair or replace any damage before use.
- Use great care when making measurements if the voltages are greater than 25VAC rms or 35VDC. These voltages are considered a shock hazard.
- Always discharge capacitors and remove power from the device under test before performing Diode, Resistance or Continuity tests.
- Voltage checks on electrical outlets can be difficult and misleading because of the uncertainty of connection to the recessed electrical contacts. Other means should be used to ensure that the terminals are not "live".
- If the equipment is used in a manner not specified by the manufacturer, the protection provided by the equipment may be impaired.
- This device is not a toy and must not reach children's hands. It contains hazardous objects as well as small parts that the children could swallow. In case a child swallows any of them, please contact a physician immediately
- Do not leave batteries and packing material lying around unattended; they can be dangerous for children if they use them as toys
- In case the device is going to be unused for an extended period of time, remove the batteries to prevent them from training
- Expired or damaged batteries can cause cauterization on contact with the skin. Always, therefore, use suitable hand gloves in such cases
- See that the batteries are not short-circuited. Do not throw batteries into the fire.
- **Do not directly view or direct the laser pointer at an eye.** Low power visible lasers do not normally present a hazard, but may present some potential for hazard if viewed directly for extended periods of time

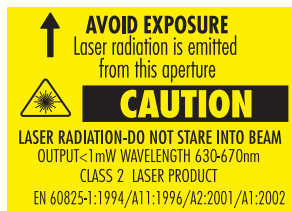

Description

Meter Description

1. Current clamp
2. Clamp opening trigger
3. Data Hold Button
4. Mode
5. Peak
6. Range
7. DCA Zero (EX830 only)
8. MIN/MAX
9. Backlit LCD Display
10. Test lead input jacks
11. IR thermometer and laser pointer (rear)
12. Backlight Button
13. Laser pointer button
14. Function switch

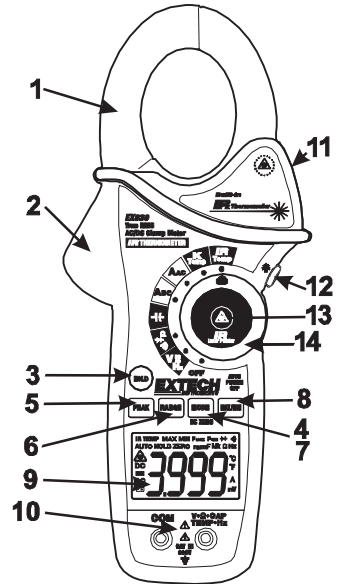

Display icons Description

HOLD	Data Hold
Minus sign	Negative reading display
0 to 3999	Measurement display digits
ZERO	Zero
P	Peak value
AUTO	Auto Range mode
DC/AC	Direct Current / Alternating
Current	
MAX	Max reading
MIN	Min reading
	Low battery
mV or V	Milli-volts or Volts (Voltage)
Ω	Ohms (Resistance)
A	Amperes (Current)
F	Farad (Capacitance)
Hz	Hertz (Frequency)
$^{\circ}\text{F}$ and $^{\circ}\text{C}$	Fahrenheit and Celsius units (Temperature)
n, m, μ , M, k	Unit of measure prefixes: nano, milli, micro, mega, and kilo
$\bullet\text{))}$	Continuity test
	Diode test
	Laser pointer

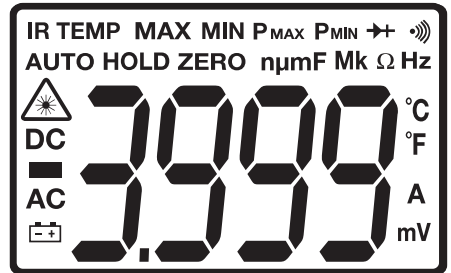

Operation

NOTES: Read and understand all **Warning** and **Caution** statements in this operation manual prior to using this meter. Set the function select switch to the OFF position when the meter is not in use.

AC Current Measurements

WARNING: Ensure that the test leads are disconnected from the meter before making current clamp measurements.

1. Set the Function switch to the **Aac** or **A_{dc}** range
2. Press the trigger to open the jaw. Fully enclose only one conductor. For optimum results, center the conductor in the jaw.
3. The clamp meter LCD will display the reading.

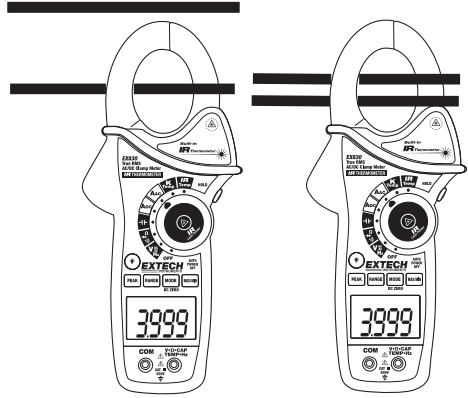

Correct

Incorrect

DCA ZERO

The DC Zero feature removes offset values and improves accuracy for DC current measurements. To perform a zero, select ADC and with no conductor in the jaw:

1. Press the **DC ZERO** button to zero the display. “**ZERO**” will appear in the display. The offset value is now stored and removed from all measurements.
2. To view the stored value, press the **DC ZERO** button. “**ZERO**” will flash and the stored value will be displayed.
3. To exit this mode, press and Hold the **ZERO** button until “**ZERO**” is no longer in the display.

AC/DC Voltage Measurements

1. Insert the black test lead into the negative **COM** terminal and the red test lead into the positive **V** terminal.
2. Set the function switch to the **V_{ac}** or **V_{dc}** position.
3. Use the **MODE** button to select AC or DC Voltage (EX830 only).
4. Connect the test leads in parallel to the circuit under test.
5. Read the voltage measurement on the LCD display.

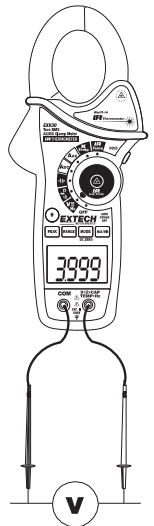

Resistance Measurements

Note: Remove power before making resistance measurements

1. Insert the black test lead into the negative **COM** terminal and the red test lead into the **Ω** positive terminal.
2. Set the function switch to the **Ω** position.
3. Touch the test probe tips across the circuit or component under test.
4. Read the resistance on the LCD display.

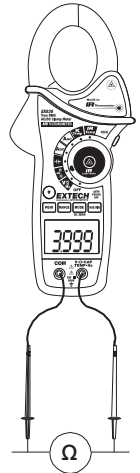

Capacitance Measurements

WARNING: To avoid electric shock, discharge the capacitor under test before measuring. If “DISC” appears in the display, remove and discharge the capacitor.

1. Set the function switch to the F capacitance position.
2. Insert the black test lead banana plug into the negative **COM** jack and the red test lead banana plug into the **CAP** positive jack.
3. Press MODE to zero any stray capacitance.
4. Touch the test probe tips across the part under test.
5. Read the capacitance value in the display.
6. The display will indicate the proper decimal point and value.

Note: For very large values of capacitance measurement time can be several minutes before the final reading stabilizes.

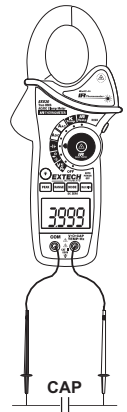

Frequency Measurements

1. Set the function switch to the **V Hz** Position.
2. Press and hold the MODE button to select the Frequency (Hz) function. “k Hz” will appear in the display.
3. Insert the black test lead banana plug into the negative COM jack and the red test lead banana plug into the Hz positive jack.
4. Touch the test probe tips across the part under test.
5. Read the Frequency value on the display.
6. The display will indicate the proper decimal point and value.
7. Press and hold the MODE button again to return to the voltage mode

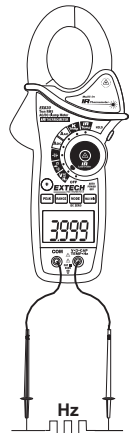

Type K Temperature Measurements

1. Set the function switch to the **K Temp** position.
2. Insert the Temperature Probe into the negative **COM** and the positive **TEMP** jacks, observing polarity.
3. Touch the Temperature Probe tip to the device under test. Continue to touch the part under test with the probe until the reading stabilizes.
4. Read the temperature on the display. The digital reading will indicate the proper decimal point and value.

WARNING: To avoid electric shock, be sure the thermocouple probe has been removed before changing to another measurement function.

Note: An open input or a temperature overrange the meter will display “OL” and beep.

Note: See the “Temperature Units” paragraph to select °F or °C

Note: The temperature range of the supplied thermocouple probe is -20 to 250°C (-4 to 482°F)



Continuity Measurements

1. Insert the black test lead into the negative **COM** terminal and the red test lead into the **Ω** positive terminal.
2. Set the function switch to the **•)))** position.
3. Use the **MODE** button to select continuity **•)))**. The display icons will change when the **MODE** button is pressed.
4. Touch the test probe tips across the circuit or component under test.
5. If the resistance is < 40Ω, a tone will sound.

Diode Test

1. Insert the black test lead banana plug into the negative **COM** jack and the red test lead banana plug into the **→+** positive jack
2. Turn the function switch to **→+** position. Use the **MODE** button to select the diode function if necessary (diode symbol will appear on the LCD when in Diode test mode)
3. Touch the test probe tips to the diode or semiconductor junction under test. Note the meter reading
4. Reverse the test lead polarity by reversing the red and black leads. Note this reading
5. The diode or junction can be evaluated as follows:
 - If one reading displays a value (typically 0.400V to 0.900V) and the other reading displays **OL**, the diode is good.
 - If both readings display **OL** the device is open.
 - If both readings are very small or '0', the device is shorted.

Non-Contact InfraRed Temperature Measurements

1. Set the function switch to the **IR Temp** position.
2. Aim the infrared sensor (rear of the meter) at the surface to be measured.
3. Press the  button in the center of the rotary function switch to turn on the laser pointer and identify the surface spot to be measured.
4. The area of the surface to be measured must be larger than the spot size as determined by the distance to spot size specification.
5. Read the temperature in the display.

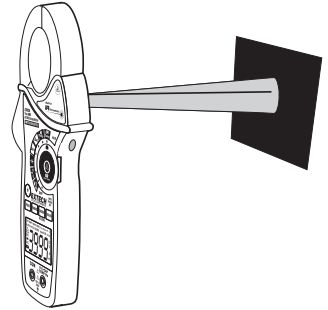

Note: See the “Temperature Units” paragraph to select °F or °C

WARNING: Do not directly view or direct the laser pointer at an eye.

Low power visible lasers do not normally present a hazard, but may present some potential for hazard if viewed directly for extended periods of time.



IR Spot to Distance Diagram

The 8:1 spot to distance ratio determines the size of the measured surface area with respect to the distance the meter is held away from the surface.

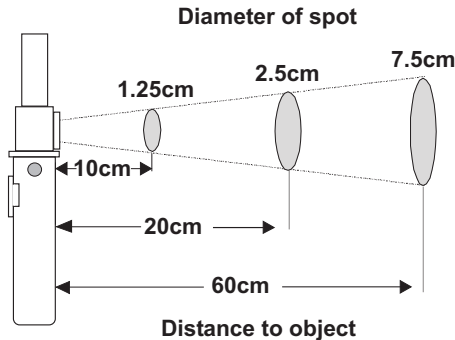

IR Measurement Notes

1. The object under test should be larger than the spot (target) size calculated by the field of view diagram.
2. If the surface of the object under test is covered with frost, oil, grime, etc., clean before taking measurements.
3. If an object's surface is highly reflective, apply masking tape or flat black paint to the surface before measuring.
4. The meter may not make accurate measurements through transparent surfaces such as glass.
5. Steam, dust, smoke, etc. can obscure measurements.
6. To find a hot spot, aim the meter outside the area of interest then scan across (in an up and down motion) until the hot spot is located.

Data Hold

To freeze the LCD reading, press the **HOLD** button. While data hold is active, the **HOLD** icon appears on the LCD. Press the **HOLD** button again to return to normal operation.

Peak Hold

The Peak Hold function captures the peak AC or DC voltage or current. The meter can capture negative or positive peaks as fast as 1 millisecond in duration.

1. Turn the function switch to the A or V position.
2. Use the **MODE** button to select AC or DC
3. Allow time for the display to stabilize.
4. Press and Hold the **PEAK** button until "**CAL**" appears in the display. This procedure will zero the range selected.
5. Press the **PEAK** button, **Pmax** will display.
6. The display will update each time a higher positive peak occurs.
7. Press the **PEAK** button again, **Pmin** will display. The display will now update and indicate the lowest negative peak.
8. To return to normal operation, press and hold the **PEAK** button until the **Pmin** or **Pmax** indicator switches off.

Note: If the Function switch position is changed after a calibration the Peak Hold calibration must be repeated for the new function selected.

MAX/MIN

1. Press the **MAX/MIN** key to activate the MAX/MIN recording mode. The display icon "**MAX**" will appear. The meter will display and hold the maximum reading and will update only when a new "max" occurs.
2. Press the **MAX/MIN** key and "**MIN**" will appear. The display icon "**MIN**" will appear. The meter will display and hold the minimum reading and will update only when a new "min" occurs.
3. Press the **MAX/MIN** key and a blinking "**MAX MIN**" will appear. The meter will display the present reading, but will continue to update and store the max and min readings.
4. To exit MAX/MIN mode press and hold the **MAX/MIN** key for 2 seconds.

Temperature Units (°F / °C)

The temperature units selection switch is located in the battery compartment. To change the units, remove the battery door, lift out the battery and set the switch for the desired units.

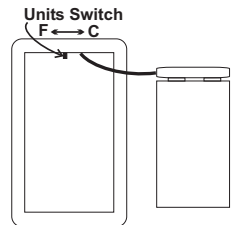

LCD Backlight Button

The LCD is equipped with backlighting for easier viewing, especially in dimly lit areas. Press the backlight button to turn the backlight on. Press again to turn the backlight off.

Automatic Power OFF

In order to conserve battery life, the meter will automatically turn off after approximately 25 minutes. To turn the meter on again, turn the function switch to the OFF position and then to the desired function position.

Maintenance

WARNING: To avoid electrical shock, disconnect the meter from any circuit, remove the test leads from the input terminals, and turn OFF the meter before opening the case. Do not operate the meter with an open case.

Cleaning and Storage

Periodically wipe the case with a damp cloth and mild detergent; do not use abrasives or solvents. If the meter is not to be used for 60 days or more, remove the battery and store it separately.

Battery Replacement

1. Remove the Phillips head screw that secures the rear battery door
2. Open the battery compartment
3. Replace the 9V battery
4. Secure the battery compartment



Never dispose of used batteries or rechargeable batteries in household waste. As consumers, users are legally required to take used batteries to appropriate collection sites, the retail store where the batteries were purchased, or wherever batteries are sold.

Disposal: Do not dispose of this instrument in household waste. The user is obligated to take end-of-life devices to a designated collection point for the disposal of electrical and electronic equipment.

Other Battery Safety Reminders

- Never dispose of batteries in a fire. Batteries may explode or leak.
- Never mix battery types. Always install new batteries of the same type

Specifications

Function	Range & Resolution	Accuracy (% of reading + digits)
AC Current 50/60 Hz	400.0 AAC	$\pm (2.5\% + 8d)$
	1000 AAC	$\pm (2.8\% + 5d)$
DC Current	400.0 ADC	$\pm (2.5\% + 5d)$
	1000 ADC	$\pm (2.8\% + 5d)$
AC Voltage 50/60Hz	400.0 mVAC	$\pm (1.0\% + 10d)$
	4.000 VAC	$\pm (1.5\% + 5d)$
	40.00 VAC	
	400.0 VAC	
	600 VAC	$\pm (2.0\% + 5d)$
DC Voltage	400.0 mVDC	$\pm (0.8\% + 2d)$
	4.000 VDC	$\pm (1.5\% + 2d)$
	40.00 VDC	
	400.0 VDC	
	600 VDC	$\pm (2.0\% + 2d)$
Resistance	400.0 Ω	$\pm (1.0\% + 4d)$
	4.000k Ω	$\pm (1.5\% + 2d)$
	40.000k Ω	
	400.0k Ω	
	4.000M Ω	$\pm (2.5\% + 3d)$
	40.00M Ω	$\pm (3.5\% + 5d)$
Capacitance	4.000nF	$\pm (5.0\% + 30d)$
	40.00nF	$\pm (5.0\% + 20d)$
	400.0nF	$\pm (3.0\% + 5d)$
	4.000 μ F	
	40.00 μ F	$\pm (4.0\% + 10d)$
	400.0 μ F	
	4.000mF	$\pm (10\% + 10d)$
	40.00mF	unspecified
Frequency	4.000kHz	$\pm (1.5\% + 2d)$
	Sensitivity: 100V (<50Hz); 50V (50 to 400Hz); 5V (401Hz to 4000Hz)	

Function	Range and Resolution	Accuracy (% of reading + digits)
Temperature (type-K)	-4 to 1400°F	± (3%rdg + 9°F)
	-20 to 760°C	± (3%rdg + 5°C)
Temp (IR)	-58 to -4°F	± 9 °F
	-4 to 518°F	±2.0% reading or ± 4°F whichever is >
	-50 to -20°C	±5°C
	-20 to 270°C	±2.0% reading or ±2°C whichever is >

Clamp jaw opening	43mm (1.7") approx.
Display	3-3/4 digits (4000 counts) backlit LCD
Continuity check	Threshold 40Ω; Test current < 0.5mA
Diode test	Test current of 0.3mA typical; Open circuit voltage < 3VDC typical
Low Battery indication	Battery symbol is displayed
Over-range indication	'OL' display
Measurement rate	2 readings per second, nominal
PEAK	Captures peaks >1ms
Thermocouple sensor	Type K thermocouple required
IR Spectral response	6 to 16μm
IR Emissivity	0.95 fixed
IR distance ratio	8:1
Input Impedance	10MΩ (VDC and VAC)
AC bandwidth	50 to 400Hz (AAC and VAC)
AC response	True rms (AAC and VAC)
Crest Factor	3.0 in 40A and 400A ranges, 1.4 in 1000A range (50/60Hz and 5% to 100% of range)
Operating Temperature	5°C to 40°C (41°F to 104°F)
Storage Temperature	-20°C to 60°C (-4°F to 140°F)
Operating Humidity	Max 80% up to 31°C(87°F) decreasing linearly to 50% at 40°C (104°F)
Storage Humidity	<80%
Operating Altitude	2000meters (7000ft) maximum.
Battery	One (1) 9V Battery (NEDA 1604)
Auto power OFF	After approx. 25 minutes
Dimensions & Weight	270x110x50mm (10.6x4.3x2"); 386g (13.6 oz)
Safety	For indoor use and in accordance with the requirements for double insulation to IEC1010-1 (2001): EN61010-1 (2001) Overvoltage Category III 600V and Category II 1000V, Pollution Degree 2.
Patent notice	U.S. Patent 7163336

Copyright © 2013-2015 FLIR Systems, Inc.

All rights reserved including the right of reproduction in whole or in part in any form

ISO-9001 Certified

www.extech.com