

WQ Series Water Quality Bench-top Meters

Model WQ500 *pH, ORP and Temperature*

Model WQ510 *pH, ORP, Conductivity, TDS, Salinity, & Temperature*

Model WQ530 *pH, ORP, Conductivity, TDS, Salinity, DO, & Temp.*

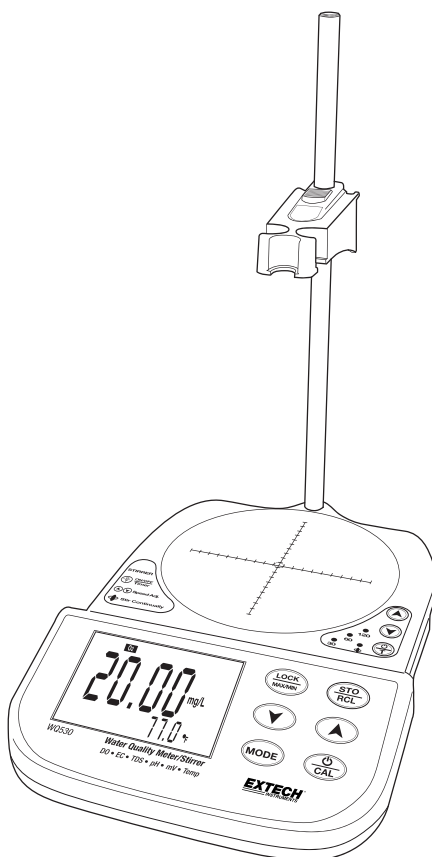

Introduction

Congratulations on your purchase of the WQ series meter. This bench top device employs leading edge technology with integrated microprocessor for measuring pH, ORP, Conductivity, DO, Salinity, TDS, and Temperature (depending on model). These devices can store 150 labeled readings for recall at a later time and includes a MAX-MIN memory feature. In addition, the WQ series meters offer a PC interface for data transfer and other remote functionality. This meter is shipped fully tested and calibrated and, with proper use, will provide years of reliable service. Please visit our website (www.extech.com) to check for the latest version of this User Guide, Product Updates, and Customer Support.

FEATURES

- Microprocessor based device with rugged housing and splash-proof keyboard
- Large backlit LCD display
- Automatic Temperature Compensation (ATC)
- Manual Salinity and Altitude Compensation
- Memory function stores and recalls up to 150 data points
- MAX-MIN store and recall
- Data Lock
- Unique measurement platform and electrode holder
- 9VDC universal AC adapter (UA100-240)
- PC interface for capturing measurement data

SUPPLIED ACCESSORIES AND EQUIPMENT

- **WQ500:**
pH glass electrode, Temp. probe, Buffer 7.00 x 100ml, Buffer 4.01 x 100ml, Electrode clamp & rod, Software and USB cable, AC/DC adaptor, Instruction manual, Gift box, Stirrer
- **WQ510**
pH glass electrode, Conductivity cell, Temp. probe, Buffer 7.00 x 100ml, Buffer 4.01 x 100ml, 1413 μ S x 100ml, 12.88mS x 100ml, Electrode clamp & rod, Software and USB cable, AC/DC adaptor, Instruction manual, Gift box, Stirrer
- **WQ530**
pH glass electrode, Conductivity cell, DO probe, Temp. probe, Membrane cap x 4 pcs, Buffer 7.00 x 100ml, Buffer 4.01 x 100ml, 1413 μ S x 100ml, 12.88mS x 100ml, Electrolyte x 50 ml, Plastic burette, Sandpaper, Electrode clamp & rod, Software and USB cable, AC/DC adaptor, Instruction manual, Gift box, Stirrer

Descriptions

METER DESCRIPTION

1. LCD Display
2. Primary Keypad
3. Secondary Keypad
4. Secondary Keypad legend
5. Beaker Test Plate
6. Rear Connection access
7. Electrode holder post
8. Electrode holder

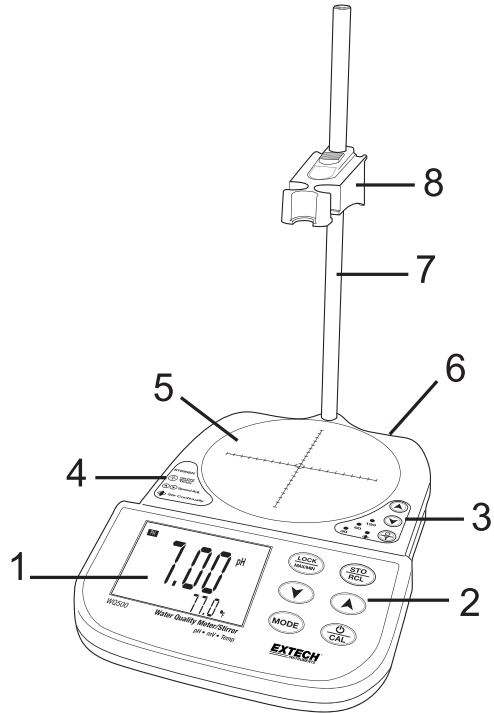





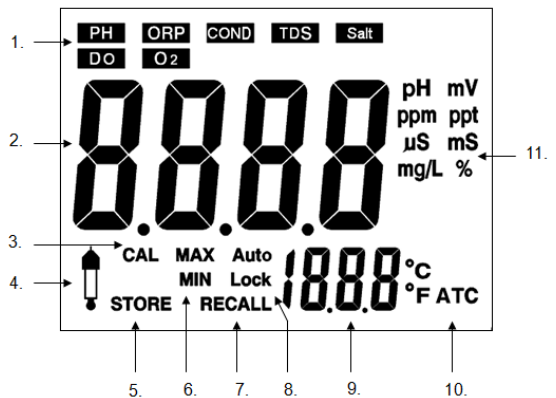

LCD DESCRIPTION

1. Measurement type
2. Primary Reading Display area
3. Calibration Mode
4. Calibration error indicator
5. Reading stored indicator
6. MAX/MIN mode icons
7. Recall Mode
8. Lock mode icon
9. Temperature reading
10. Auto temperature condensation
11. Units of measure icons



KEYPAD DESCRIPTION

	<p>Lock the current reading on the LCD. Press and hold for 3 seconds to enter or exit MAX/MIN mode. In MAX/MIN mode, press to browse MAX and MIN readings.</p>
	<p>Store the current reading. Press and hold for 3 seconds to enter Recall mode.</p>
	<p>In Recall mode, use the up and down arrows to browse records. Press and hold simultaneously for 3 seconds to enter the advanced setting mode (see Advanced Settings section).</p>
	
	<p>Select a measurement function. Press and hold for 3 seconds to switch C/F or switch pH-mV or ORP-mV (in ORP mode), or switch mg/L to ppm (in DO mode)</p>
	<p>Switch Power ON or OFF. Press and hold for 3 seconds to enter the Calibration mode</p>

1. Increase stirrer speed
2. Decrease stirrer speed
3. Press to turn on the stirrer or set stir mode (30, 60, 120 minutes or continuously); Press 3 sec. to turn off the stirrer
4. Stir mode LED indicator: 30, 60, 120 minutes or stir continuously.

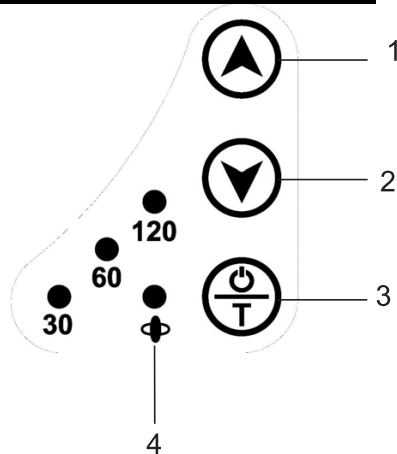

Preparation

pH, ORP, Conductivity, TDS (Total Dissolved Solids), and Salinity

1. Connect AC adapter to a power source.
2. Remove the protection cap from the electrode and connect to the input connector.
3. Connect the temperature probe to the meter and power on.
4. Rinse the electrode with clean water and wipe dry.

DO (Dissolved Oxygen)

1. Connect the DO probe and temperature probe to the meter and remove the protective cap.
2. Carefully remove the membrane cap.
3. Fill membrane cap with the electrode solution to the bottom of the threads inside the cap.
4. Press the Power button to switch the meter ON.

Calibration and Operation

pH Calibration (NOTE: ORP does not require calibration)

Before accurate measurements can be obtained, it is necessary to calibrate the meter with the electrode. Typically, pH 7 is calibrated first and then one or more of the other buffers.

1. Connect the pH electrode to the meter's BNC connector input.
2. Dip the electrode and temperature probe into the pH 7.00 buffer solution. Stir gently and wait for a stable reading.
3. Press and hold the Power button for 3 seconds to enter calibration mode.
4. The LCD will display **CAL** and a **7.00** will flash.
5. When calibration is complete the display will stop flashing and show **SA** then **END**.
6. The meter will now return to normal operating mode.
7. Rinse the electrode and wipe dry. Dip the electrode in pH 4.01 or pH 10.01. The LCD will indicate a percentage of slope (PTS) to show the status of the electrode.
8. If PTS is below 70% or above 130% the electrode must be replaced. A slope of 100% is ideal.

Notes:

1. Calibration error indicator icon will appear (**Err** instead of **SA**) if calibration fails.
2. When doing a 2 or 3 point calibration, calibrate with buffer pH 7 first, and then follow with buffer pH 4 or pH 10.
3. pH calibration type "**USA**" or "**NIST**" can be changed in the Advanced Setting mode (see the Advanced Settings section).
4. The calibration points for "**USA**" are 1.68, 4.01, 7.00, 10.01 and 12.45.
5. The calibration points for "**NIST**" are 1.68, 4.01, 6.86, 9.18 and 12.45.

ORP Calibration

Calibration is not necessary for ORP. However, ORP should be verified with ORP standard solution to check whether the electrode is in proper working order or not.

Conductivity, TDS, and Salinity Calibration

1. Dip the Conductivity cell and the temperature probe into the standard solution 1413 $\mu\text{S}/\text{cm}$.
2. Stir gently and wait until the reading is stable.
3. Press and hold the Power button for 3 sec. to enter the calibration mode. The display will show **CAL** and **1413 $\mu\text{S}/\text{cm}$** will flash.
4. When calibration is complete the display will stop flashing and indicate **SA**, then **End**. The meter will then return to the normal operating mode.

Notes:

1. Calibrating with 12.88 mS/cm standard solution is better for measuring with high conductivity solutions.
2. The icon **COND** will display automatically during calibration mode.
3. Calibration error indicator icon will appear (**Err** instead of **SA**) if calibration fails.
4. If the reading is not 0 $\mu\text{S}/\text{cm}$ while the cell is in air (not dipped into any solution), calibrate in air to obtain a reading of 0 $\mu\text{S}/\text{cm}$.
5. The Conductivity calibration points are: 0, 84 $\mu\text{S}/\text{cm}$, 1413 $\mu\text{S}/\text{cm}$, 12.88mS/cm and 80.0mS/cm.

DO Calibration

1. With the DO probe attached, press Power button to turn on meter and then press MODE to select **O2** mode.
2. Wait 10 to 30 minutes for the probe to polarize. The reading should be approx. 101.7% (saturation) after the probe has completely polarized
3. Remove the probe. Press and hold Power for 3 sec. to enter calibration mode. The display will show **CAL** and **101.7%** will flash. The display will stop flashing and indicate **SA**, then **End** when calibration is complete. The meter will return to the normal operating mode.
4. Optional 'zero oxygen' calibration: (improves measurement accuracy for very low or very high DO measurements). Place the probe into a zero oxygen calibration solution, such as 5% sodium sulfite, wait for stability and press and hold Power to enter calibration. Stability in a zero solution may take many minutes, depending on probe history.

Note:

1. The icon **O2** will display automatically during calibration mode.
2. Calibration error indicator icon will appear (**Err** instead of **SA**) if calibration fails.
3. If the reading is not 0% when the probe is disconnected, calibrate it in air without probe to obtain a reading of 0%.

pH Measurement

1. Press MODE to choose pH mode.
2. After calibration, rinse the pH electrode with clean water and wipe it dry.
3. Dip the electrode and the temperature probe into the sample solution that is going to be measured.
4. Stir gently and wait until a stable reading can be obtained.

ORP Measurement

1. Insert the ORP electrode, and press MODE to choose ORP mode.
2. Rinse the ORP electrode with clean water and wipe it dry.
3. Dip the electrode into the sample solution that is going to be measured.
4. Stir gently and wait until a stable reading can be obtained.

Notes:

1. The display will show “----” in an over-range condition.
2. After measurement, rinse the electrode with clean water.
3. Replace the soaking bottle. The bottle should always be filled with soaking solution (4M KCL).

COND, TDS, Salinity Measurement

1. Insert Conductivity cell, and press MODE to choose COND, TDS or Salt mode.
2. After calibration, rinse the conductivity cell with clean water and wipe it dry.
3. Dip the electrode and the temperature probe into the sample solution that is going to be measured.
4. Stir gently and wait until a stable reading can be obtained.

Notes:

1. The display will show “----” in an over-range condition.
2. The meter auto-ranges to $\mu\text{S}/\text{cm}$ or mS/cm , or ppm or ppt.
3. After measurement, rinse the cell with clean water and replace the protective cap.
4. Do not touch or wipe the surface of the inner black plate of the conductivity cell.

DO Measurement

1. Remove the protection cap and turn on the power and press MODE to choose O2 mode. Wait 10 to 30 minutes for the probe to polarize. The reading should be approx. 101.7% (saturation) after the probe has completely polarized.
2. Select the desired units of measure by pressing MODE until the proper units are shown in the display.
3. Place the probe in the sample to be measured. Stir the probe in the sample to remove any trapped air bubbles from the membrane surface.
4. Allow the meter time to settle to the final measurement value.

Notes:

1. The larger the difference in temperature between the probe and the solution, the longer it will take for the reading to stabilize. Stabilization time can vary from ten (10) seconds to five (5) minutes.
2. Cover the probe with the probe cap. The sponge contained in the cap should be moistened (not soaked) with DI (distilled water) or clean tap water.

150-Reading Measurement Store and Recall

1. Press the STORE/RECALL button to store the current reading. Press each time a reading is to be stored. The STORE icon appears as a reading is stored.
2. If an attempt is made to store more than 150 readings, the stored readings (starting with the first reading) will be overwritten.
3. To recall readings, press and hold the STORE/RECALL button until the 'RECALL' icon appears on the LCD. Use the up/down arrow buttons to scroll through the stored readings.
4. To exit this mode, press STORE/RECALL to return to normal operating mode.
5. Press and hold the up and down buttons simultaneously for 3 seconds to clear the memory.

MAX/MIN Memory Display

1. The meter memorizes the highest (MAX) and lowest (MIN) readings when prompted.
2. Press and hold the MAX/MIN button until both the MAX and MIN icons appear flashing on the LCD. The meter will now begin keeping track of the MIN and MAX readings.
3. To view MAX/MIN values, press the MAX/MIN button again; the meter automatically displays the highest and lowest readings in succession and then returns to the MAX/MIN recording mode.
4. To exit the MAX/MIN mode, press and hold the MAX/MIN button until the MAX and MIN icons disappear.

Advanced Settings

In pH, TDS, or DO mode press the up and down arrows simultaneously for 3 seconds to enter the Advanced Setup mode.

pH Advanced Settings

1. In pH setting mode, press STORE/RECALL button to set the pH calibration type. Use the up and down arrows to select **USA** or **NIST**. USA and NIST calibration points differ, refer to the Calibration section of this guide for comparison of calibration points.
2. Press MODE to save setting and return to normal operating mode.
3. Press LOCK/MAXMIN to turn AUTO LOCK ON or OFF. Use the up and down arrows to select **ON** or **OFF**. In Auto Lock mode the keypad is locked and cannot be tampered.
4. Press MODE to save setting and return to normal operating mode.

TDS Advanced Settings

1. Press STORE/RECALL to set the ratio between conductivity and TDS.
2. Use the up and down arrows to adjust the ratio from 0.5 to 1.0 and then press MODE to save setting and return to normal operating mode.

DO Advanced Settings

1. Press STORE/RECALL to set the salt compensation. Use the up and down arrows to adjust the value from 0 to 50 ppt.
2. Press MODE to save setting and return to normal operating mode.
3. Press LOCK to set the altitude compensation. Use the up and down arrows to adjust the value from 0 to 7000m (20000 ft.).
4. Press MODE to save setting and return to normal operating mode.

Note: In any advanced setting mode, press the power button to reset all settings back to factory setup (except pH calibration and Auto lock)

PC Interface

This WQ series meter can be connected to a PC for data transfer and other remote functionality. Please refer to the PC Interface Software Instructions supplied on the included program CD-ROM and/or the instructions provided in the HELP Utility of the Software Program itself once it is opened. Please contact our Customer Care Technical Support department for further PC interface-related assistance. Check the website www.extech.com software download page for the latest version of program and for the operating system compatibility.

Membrane Cap Replacement

IMPORTANT NOTE: Only the electrolyte solution supplied by Extech will work correctly for this probe. If a third party solution is used, the probe will not work normally.

1. Do not touch the membrane as skin oils will interfere with the oxygen permeability rate of the membrane. Replace the cap carefully.
2. It is recommended that the probe remain attached to the meter during this replacement process.
3. Unscrew the cap firmly and carefully from the probe.
4. Rinse the old electrolyte solution from the Cathode and Anode.
5. Use the supplied Polishing Strips to clean, polish, shine, and/or remove scratches from the cathode. Be sure to moisten the cloth before polishing the cathode. Do not over-polish the sensitive gold cathode.
6. Set the new replacement membrane cap on a flat surface. Leave the cap in this position during the replacement process.
7. Fill the membrane cap with the electrolyte solution up to the bottom of the threads on the inside of the cap.
8. Tap the membrane cap to release and prevent air bubble in electrolyte solution.
9. Keeping the cap in a fixed position on a flat surface, carefully insert the probe into the new cap by first dipping and removing the probe several times from the cap. With each dip, push the probe progressively deeper into the bonded cap. Finally, screw the probe slowly onto the cap until fully tightened. The dipping and removal technique minimizes the introduction of air bubbles into the electrolyte solution. Air bubbles in the electrolyte can affect measurements.
10. It is normal that excess electrolyte solution will leak from the cap during this replacement since it minimizes the introduction of air pockets. Clean off the excess electrolyte before use.

- 1) Membrane Cap
- 2) Cathode
- 3) Anode
- 4) DO Probe

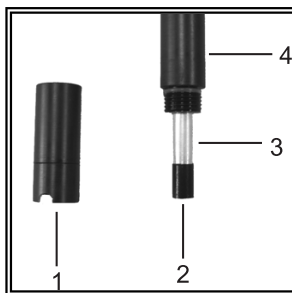

Cleaning the DO Probe

When the DO reading is unstable or incorrect, the probe needs to be cleaned:

1. Unscrew the membrane cap from the probe.
2. Place sand paper on a table with the coarse side face up, and add some water.
3. Rub the cathode part against the sand paper about 10 times.
4. Use the sand paper to clean the anode part.
5. After cleaning the probe, please refill membrane cap with new electrolyte.

Probe Storage

pH probe (WQ-PH)

After use, clean the probe tip with distilled water. The probe tip needs to be stored wet in pH4 buffer solution. Place the protective cap with pH4 solution over the end of the probe.

ORP probe (67500B)

After use, clean the probe tip with distilled water. The probe tip needs to be stored wet in pH4 buffer solution or 4.0 M KCL solution. Place the protective cap with the solution over the end of the probe.

Conductivity Probe (WQ-EC)

After use, clean the probe tip with distilled water. The probe should be stored wet in deionized or distilled water. Place the protective cap with the water over the end of the probe.

Dissolved Oxygen probe (WQ-DO)

After use, clean the probe tip with distilled water.

Short term storage - Less than 2 weeks

The probe should be stored wet in deionized or distilled water. Place the protective cap with the water over the end of the probe.

Long term storage – more than 2 weeks

The probe should be stored dry. Remove the membrane cap and rinse off the electrode with deionized or distilled water and then allow the electrode to dry. Place the membrane cap back over the electrode for protection and place the probe tip into the protective cap.

Specifications

	pH	ORP
Range	-2.00 to 16.00 pH	-1999 to -200 mV -199.9 to 499.9 mV 500 to 1999 mV
Accuracy	±(0.02%FS + 1d)	±(2%FS + 1 digit)
Resolution	0.01 pH	0.1/1 mV
Compensation	ATC: 0 to 100°C (32 to 212°F)	N/A

	Conductivity	TDS	Salt
Range	0.0 to 199.9µS 200 to 1999µS 2.00 to 19.99 mS 20.0 to 100.0 mS	0.0 to 131.9 ppm 132 to 1319 ppm 1.32 to 13.19 ppt 13.2 to 66.0 ppt	0.0 to 99.9 ppm 100 to 999 ppm 1.00 to 9.99 ppt 10.0 to 50.0 ppt
Accuracy	±2% FS	±2% FS	±2% FS
Resolution	0.1/1µS/0.01/0.1mS	0.1/1ppm/0.01/0.1ppt	0.1/1ppm/0.01/0.1ppt
Compensation	ATC: 0 to 60°C (32 to 140°F)	ATC: 0 to 60°C (32 to 140°F)	ATC: 0 to 60°C (32 to 140°F)

	DO	O2	Temperature
Range	0 to 20.00 mg/L 0 to 20.00 ppm	0 to 200.0 %	0 to 110°C (32 to 230°F)
Accuracy	± (0.2%FS + 1 digit)	±2% FS	±1°C (±1.8°F) Note: Accuracy is rated between 10 and 65°C (50 and 149°F)
Resolution	0.01 mg/L	0.10%	0.1 °C/F
Compensation	Automatic Temperature Compensation (ATC): 0 to 60 °C (32 to 140°F) Manual Salinity Compensation (MSC): 0 to 50 ppt Manual Altitude Compensation (MAC): 0 to 7000m (20000 ft.)		

Operating Temperature	0 to 50°C (32 to 122°F)
Operating Humidity	85% maximum (non-condensing)
Power	9Vdc, universal AC adapter
Dimensions	24cm (L) x 17cm (W) x 5.7cm (H) or 31.2cm (H) with rod 9.5" (L) x 6.7" (W) x 2.2" (H) or 12.3" (H) with rod
Weight	740g (1.6 lbs.)

Copyright © 2013-2015 FLIR Systems, Inc.

All rights reserved including the right of reproduction in whole or in part in any form

www.extech.com